

Part I Artificial Intelligence

1 Introduction

2 Intelligent Agents

Part II Problem Solving

3 Solving Problems by Searching

4 Informed Search and Exploration

5 Constraint Satisfaction Problems

6 Adversarial Search

Part III Knowledge and Reasoning

7 Logical Agents

8 First-Order Logic

9 Inference in First-Order Logic

Part V Uncertain Knowledge and Reasoning

13 Uncertainty

14 Probabilistic Reasoning

Part V Learning

18 Learning from Observations

Part VII Communicating, Perceiving, and Acting

22 Communication

INFERENCE IN FIRST-ORDER LOGIC

CHAPTER 9

Outline

- ◇ Reducing first-order inference to propositional inference
- ◇ Unification
- ◇ Generalized Modus Ponens
- ◇ Forward and backward chaining
- ◇ Logic programming
- ◇ Resolution

A brief history of reasoning

450B.C.	Stoics	propositional logic, inference (maybe)
322B.C.	Aristotle	“syllogisms” (inference rules), quantifiers
1565	Cardano	probability theory (propositional logic + uncertainty)
1847	Boole	propositional logic (again)
1879	Frege	first-order logic
1922	Wittgenstein	proof by truth tables
1930	Gödel	\exists complete algorithm for FOL
1930	Herbrand	complete algorithm for FOL (reduce to propositional)
1931	Gödel	$\neg\exists$ complete algorithm for arithmetic
1960	Davis/Putnam	“practical” algorithm for propositional logic
1965	Robinson	“practical” algorithm for FOL—resolution

Universal instantiation (UI)

Every instantiation of a universally quantified sentence is entailed by it:

$$\frac{\forall v \alpha}{\text{SUBST}(\{v/g\}, \alpha)}$$

for any variable v and ground term g

E.g., $\forall x \text{ King}(x) \wedge \text{Greedy}(x) \Rightarrow \text{Evil}(x)$ yields

$$\text{King}(\text{John}) \wedge \text{Greedy}(\text{John}) \Rightarrow \text{Evil}(\text{John})$$

$$\text{King}(\text{Richard}) \wedge \text{Greedy}(\text{Richard}) \Rightarrow \text{Evil}(\text{Richard})$$

$$\text{King}(\text{Father}(\text{John})) \wedge \text{Greedy}(\text{Father}(\text{John})) \Rightarrow \text{Evil}(\text{Father}(\text{John}))$$

⋮

Existential instantiation (EI)

For any sentence α , variable v , and constant symbol k that does not appear elsewhere in the knowledge base:

$$\frac{\exists v \alpha}{\text{SUBST}(\{v/k\}, \alpha)}$$

E.g., $\exists x \text{Crown}(x) \wedge \text{OnHead}(x, \text{John})$ yields

$$\text{Crown}(C_1) \wedge \text{OnHead}(C_1, \text{John})$$

provided C_1 is a new constant symbol, called a Skolem constant

Another example: from $\exists x \frac{d(x^y)}{dy} = x^y$ we obtain

$$\frac{d(e^y)}{dy} = e^y$$

provided e is a new constant symbol

Existential instantiation contd.

UI can be applied several times to **add** new sentences;
the new KB is logically equivalent to the old

EI can be applied once to **replace** the existential sentence;
the new KB is **not** equivalent to the old,
but is satisfiable iff the old KB was satisfiable

Reduction to propositional inference

Suppose the KB contains just the following:

$$\forall x \text{ King}(x) \wedge \text{Greedy}(x) \Rightarrow \text{Evil}(x)$$

$$\text{King}(\text{John})$$

$$\text{Greedy}(\text{John})$$

$$\text{Brother}(\text{Richard}, \text{John})$$

Instantiating the universal sentence in **all possible** ways, we have

$$\text{King}(\text{John}) \wedge \text{Greedy}(\text{John}) \Rightarrow \text{Evil}(\text{John})$$

$$\text{King}(\text{Richard}) \wedge \text{Greedy}(\text{Richard}) \Rightarrow \text{Evil}(\text{Richard})$$

$$\text{King}(\text{John})$$

$$\text{Greedy}(\text{John})$$

$$\text{Brother}(\text{Richard}, \text{John})$$

The new KB is **propositionalized**: proposition symbols are

$$\text{King}(\text{John}), \text{Greedy}(\text{John}), \text{Evil}(\text{John}), \text{King}(\text{Richard}) \text{ etc.}$$

Reduction contd.

Claim: a ground sentence* is entailed by new KB iff entailed by original KB

Claim: every FOL KB can be propositionalized so as to preserve entailment

Idea: propositionalize KB and query, apply resolution, return result

Problem: with function symbols, there are infinitely many ground terms,
e.g., *Father(Father(Father(John)))*

Theorem: Herbrand (1930). If a sentence α is entailed by an FOL KB,
it is entailed by a **finite** subset of the propositional KB

Idea: For $n = 0$ to ∞ do
 create a propositional KB by instantiating with depth- n terms
 see if α is entailed by this KB

Problem: works if α is entailed, loops if α is not entailed

Theorem: Turing (1936), Church (1936), entailment in FOL is **semidecidable**

Problems with propositionalization

Propositionalization seems to generate lots of irrelevant sentences.

E.g., from

$$\forall x \text{ King}(x) \wedge \text{Greedy}(x) \Rightarrow \text{Evil}(x)$$

$$\text{King}(\text{John})$$

$$\forall y \text{ Greedy}(y)$$

$$\text{Brother}(\text{Richard}, \text{John})$$

it seems obvious that $\text{Evil}(\text{John})$, but propositionalization produces lots of facts such as $\text{Greedy}(\text{Richard})$ that are irrelevant

With p k -ary predicates and n constants, there are $p \cdot n^k$ instantiations

With function symbols, it gets much much worse!

Unification

We can get the inference immediately if we can find a substitution θ such that $King(x)$ and $Greedy(x)$ match $King(John)$ and $Greedy(y)$

$\theta = \{x/John, y/John\}$ works

$UNIFY(\alpha, \beta) = \theta$ if $\alpha\theta = \beta\theta$

p	q	θ
$Knows(John, x)$	$Knows(John, Jane)$	
$Knows(John, x)$	$Knows(y, OJ)$	
$Knows(John, x)$	$Knows(y, Mother(y))$	
$Knows(John, x)$	$Knows(x, OJ)$	

Unification

We can get the inference immediately if we can find a substitution θ such that $King(x)$ and $Greedy(x)$ match $King(John)$ and $Greedy(y)$

$\theta = \{x/John, y/John\}$ works

UNIFY(α, β) = θ if $\alpha\theta = \beta\theta$

p	q	θ
$Knows(John, x)$	$Knows(John, Jane)$	$\{x/Jane\}$
$Knows(John, x)$	$Knows(y, OJ)$	
$Knows(John, x)$	$Knows(y, Mother(y))$	
$Knows(John, x)$	$Knows(x, OJ)$	

Unification

We can get the inference immediately if we can find a substitution θ such that $King(x)$ and $Greedy(x)$ match $King(John)$ and $Greedy(y)$

$\theta = \{x/John, y/John\}$ works

$UNIFY(\alpha, \beta) = \theta$ if $\alpha\theta = \beta\theta$

p	q	θ
$Knows(John, x)$	$Knows(John, Jane)$	$\{x/Jane\}$
$Knows(John, x)$	$Knows(y, OJ)$	$\{x/OJ, y/John\}$
$Knows(John, x)$	$Knows(y, Mother(y))$	
$Knows(John, x)$	$Knows(x, OJ)$	

Unification

We can get the inference immediately if we can find a substitution θ such that $King(x)$ and $Greedy(x)$ match $King(John)$ and $Greedy(y)$

$\theta = \{x/John, y/John\}$ works

$UNIFY(\alpha, \beta) = \theta$ if $\alpha\theta = \beta\theta$

p	q	θ
$Knows(John, x)$	$Knows(John, Jane)$	$\{x/Jane\}$
$Knows(John, x)$	$Knows(y, OJ)$	$\{x/OJ, y/John\}$
$Knows(John, x)$	$Knows(y, Mother(y))$	$\{y/John, x/Mother(John)\}$
$Knows(John, x)$	$Knows(x, OJ)$	

Unification

We can get the inference immediately if we can find a substitution θ such that $King(x)$ and $Greedy(x)$ match $King(John)$ and $Greedy(y)$

$\theta = \{x/John, y/John\}$ works

$UNIFY(\alpha, \beta) = \theta$ if $\alpha\theta = \beta\theta$

p	q	θ
$Knows(John, x)$	$Knows(John, Jane)$	$\{x/Jane\}$
$Knows(John, x)$	$Knows(y, OJ)$	$\{x/OJ, y/John\}$
$Knows(John, x)$	$Knows(y, Mother(y))$	$\{y/John, x/Mother(John)\}$
$Knows(John, x)$	$Knows(x, OJ)$	$fail$

Standardizing apart eliminates overlap of variables, e.g., $Knows(z_{17}, OJ)$

Generalized Modus Ponens (GMP)

$$\frac{p_1', p_2', \dots, p_n', (p_1 \wedge p_2 \wedge \dots \wedge p_n \Rightarrow q)}{q\theta}$$

where $p_i'\theta = p_i\theta$ for all i

p_1' is *King(John)* p_1 is *King(x)*
 p_2' is *Greedy(y)* p_2 is *Greedy(x)*
 θ is $\{x/\text{John}, y/\text{John}\}$ q is *Evil(x)*
 $q\theta$ is *Evil(John)*

GMP used with KB of definite clauses (**exactly** one positive literal)

All variables assumed universally quantified

Soundness of GMP

Need to show that

$$p_1', \dots, p_n', (p_1 \wedge \dots \wedge p_n \Rightarrow q) \models q\theta$$

provided that $p_i'\theta = p_i\theta$ for all i

Lemma: For any definite clause p , we have $p \models p\theta$ by UI

1. $(p_1 \wedge \dots \wedge p_n \Rightarrow q) \models (p_1 \wedge \dots \wedge p_n \Rightarrow q)\theta = (p_1\theta \wedge \dots \wedge p_n\theta \Rightarrow q\theta)$
2. $p_1', \dots, p_n' \models p_1' \wedge \dots \wedge p_n' \models p_1'\theta \wedge \dots \wedge p_n'\theta$
3. From 1 and 2, $q\theta$ follows by ordinary Modus Ponens

Example knowledge base

The law says that it is a crime for an American to sell weapons to hostile nations. The country Nono, an enemy of America, has some missiles, and all of its missiles were sold to it by Colonel West, who is American.

Prove that Col. West is a criminal

Example knowledge base contd.

... it is a crime for an American to sell weapons to hostile nations:

Example knowledge base contd.

... it is a crime for an American to sell weapons to hostile nations:

$$\textit{American}(x) \wedge \textit{Weapon}(y) \wedge \textit{Sells}(x, y, z) \wedge \textit{Hostile}(z) \Rightarrow \textit{Criminal}(x)$$

Nono ... has some missiles

Example knowledge base contd.

... it is a crime for an American to sell weapons to hostile nations:

$American(x) \wedge Weapon(y) \wedge Sells(x, y, z) \wedge Hostile(z) \Rightarrow Criminal(x)$

Nono ... has some missiles, i.e., $\exists x Owns(Nono, x) \wedge Missile(x)$:

$Owns(Nono, M_1)$ and $Missile(M_1)$

... all of its missiles were sold to it by Colonel West

Example knowledge base contd.

... it is a crime for an American to sell weapons to hostile nations:

$$\textit{American}(x) \wedge \textit{Weapon}(y) \wedge \textit{Sells}(x, y, z) \wedge \textit{Hostile}(z) \Rightarrow \textit{Criminal}(x)$$

Nono ... has some missiles, i.e., $\exists x \textit{Owns}(\textit{Nono}, x) \wedge \textit{Missile}(x)$:

$$\textit{Owns}(\textit{Nono}, M_1) \text{ and } \textit{Missile}(M_1)$$

... all of its missiles were sold to it by Colonel West

$$\forall x \textit{Missile}(x) \wedge \textit{Owns}(\textit{Nono}, x) \Rightarrow \textit{Sells}(\textit{West}, x, \textit{Nono})$$

Missiles are weapons:

Example knowledge base contd.

... it is a crime for an American to sell weapons to hostile nations:

$$\textit{American}(x) \wedge \textit{Weapon}(y) \wedge \textit{Sells}(x, y, z) \wedge \textit{Hostile}(z) \Rightarrow \textit{Criminal}(x)$$

Nono ... has some missiles, i.e., $\exists x \textit{Owns}(\textit{Nono}, x) \wedge \textit{Missile}(x)$:

$$\textit{Owns}(\textit{Nono}, M_1) \text{ and } \textit{Missile}(M_1)$$

... all of its missiles were sold to it by Colonel West

$$\forall x \textit{Missile}(x) \wedge \textit{Owns}(\textit{Nono}, x) \Rightarrow \textit{Sells}(\textit{West}, x, \textit{Nono})$$

Missiles are weapons:

$$\textit{Missile}(x) \Rightarrow \textit{Weapon}(x)$$

An enemy of America counts as "hostile":

Example knowledge base contd.

... it is a crime for an American to sell weapons to hostile nations:

$$\textit{American}(x) \wedge \textit{Weapon}(y) \wedge \textit{Sells}(x, y, z) \wedge \textit{Hostile}(z) \Rightarrow \textit{Criminal}(x)$$

Nono ... has some missiles, i.e., $\exists x \textit{Owns}(\textit{Nono}, x) \wedge \textit{Missile}(x)$:

$$\textit{Owns}(\textit{Nono}, M_1) \text{ and } \textit{Missile}(M_1)$$

... all of its missiles were sold to it by Colonel West

$$\forall x \textit{Missile}(x) \wedge \textit{Owns}(\textit{Nono}, x) \Rightarrow \textit{Sells}(\textit{West}, x, \textit{Nono})$$

Missiles are weapons:

$$\textit{Missile}(x) \Rightarrow \textit{Weapon}(x)$$

An enemy of America counts as "hostile":

$$\textit{Enemy}(x, \textit{America}) \Rightarrow \textit{Hostile}(x)$$

West, who is American ...

$$\textit{American}(\textit{West})$$

The country Nono, an enemy of America ...

$$\textit{Enemy}(\textit{Nono}, \textit{America})$$

Forward chaining algorithm

```
function FOL-FC-ASK( $KB, \alpha$ ) returns a substitution or false
  repeat until new is empty
     $new \leftarrow \{ \}$ 
    for each sentence  $r$  in  $KB$  do
       $(p_1 \wedge \dots \wedge p_n \Rightarrow q) \leftarrow \text{STANDARDIZE-APART}(r)$ 
      for each  $\theta$  such that  $(p_1 \wedge \dots \wedge p_n)\theta = (p'_1 \wedge \dots \wedge p'_n)\theta$ 
        for some  $p'_1, \dots, p'_n$  in  $KB$ 
           $q' \leftarrow \text{SUBST}(\theta, q)$ 
          if  $q'$  is not a renaming of a sentence already in  $KB$  or new then do
            add  $q'$  to new
             $\phi \leftarrow \text{UNIFY}(q', \alpha)$ 
            if  $\phi$  is not fail then return  $\phi$ 
    add new to  $KB$ 
  return false
```

Forward chaining proof

American(West)

Missile(M1)

Owns(Nono,M1)

Enemy(Nono,America)

Forward chaining proof

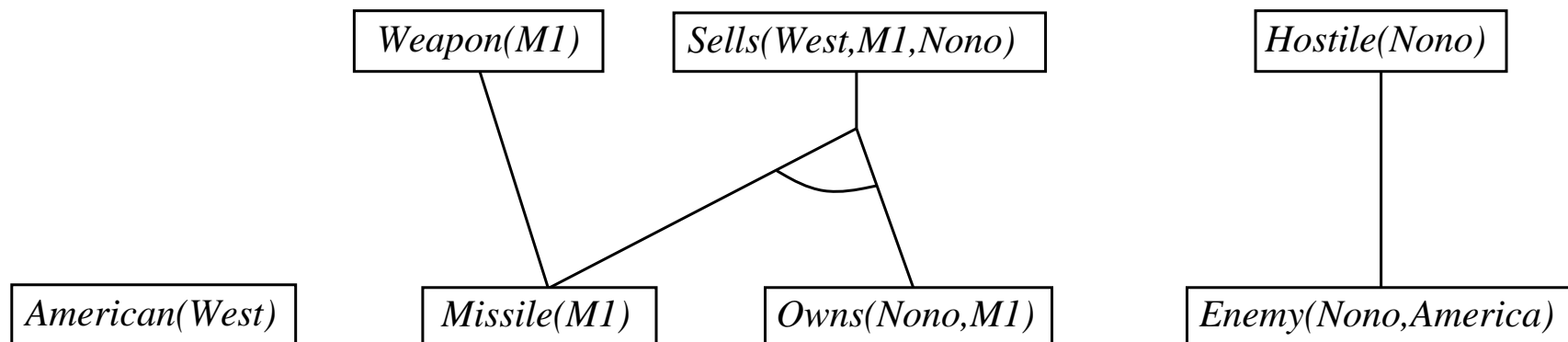

Forward chaining proof

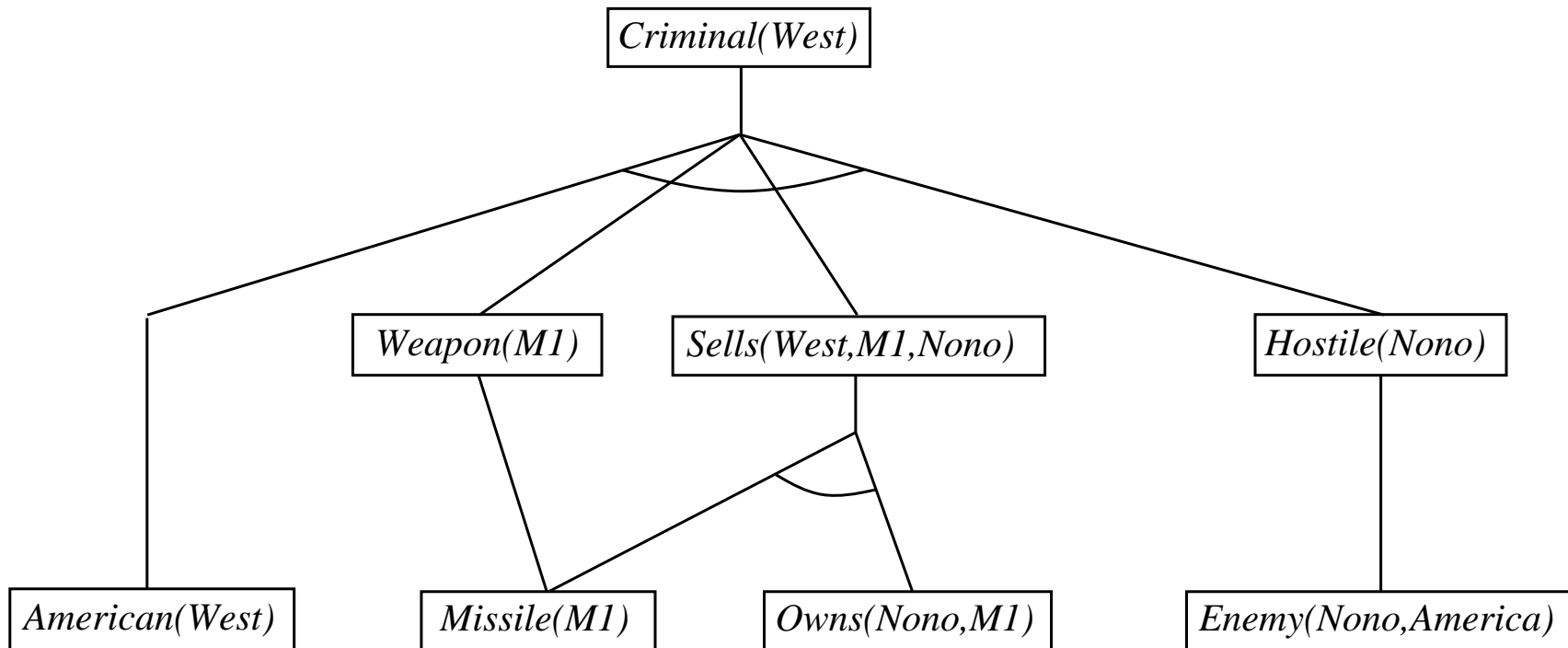

Properties of forward chaining

Sound and complete for first-order definite clauses
(proof similar to propositional proof)

Datalog = first-order definite clauses + **no functions** (e.g., crime KB)

FC terminates for Datalog in poly iterations: at most $p \cdot n^k$ literals

May not terminate in general if α is not entailed

This is unavoidable: entailment with definite clauses is semidecidable

Efficiency of forward chaining

Simple observation: no need to match a rule on iteration k
if a premise wasn't added on iteration $k - 1$

⇒ match each rule whose premise contains a newly added literal

Matching itself can be expensive

Database indexing allows $O(1)$ retrieval of known facts

e.g., query $Missile(x)$ retrieves $Missile(M_1)$

Matching conjunctive premises against known facts is NP-hard

Forward chaining is widely used in deductive databases

Hard matching example

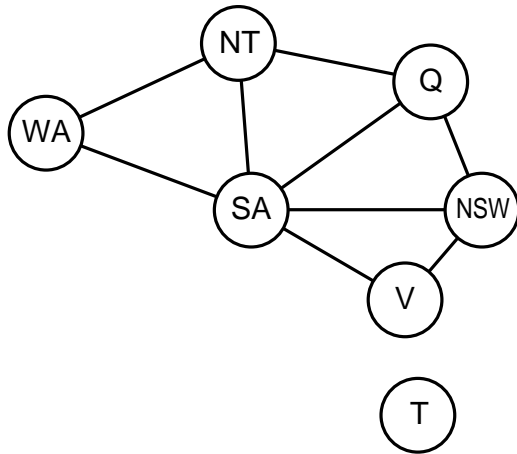

$$\begin{aligned} & Diff(wa, nt) \wedge Diff(wa, sa) \wedge \\ & Diff(nt, q) Diff(nt, sa) \wedge \\ & Diff(q, nsw) \wedge Diff(q, sa) \wedge \\ & Diff(nsw, v) \wedge Diff(nsw, sa) \wedge \\ & Diff(v, sa) \Rightarrow Colorable() \end{aligned}$$

$$\begin{aligned} & Diff(Red, Blue) \quad Diff(Red, Green) \\ & Diff(Green, Red) \quad Diff(Green, Blue) \\ & Diff(Blue, Red) \quad Diff(Blue, Green) \end{aligned}$$

Colorable() is inferred iff the CSP has a solution

CSPs include 3SAT as a special case, hence matching is NP-hard

Backward chaining algorithm

```
function FOL-BC-ASK(KB, goals,  $\theta$ ) returns a set of substitutions
inputs: KB, a knowledge base
           goals, a list of conjuncts forming a query ( $\theta$  already applied)
            $\theta$ , the current substitution, initially the empty substitution { }
local variables: answers, a set of substitutions, initially empty

if goals is empty then return { $\theta$ }
 $q' \leftarrow$  SUBST( $\theta$ , FIRST(goals))
for each sentence r in KB
    where STANDARDIZE-APART(r) = ( $p_1 \wedge \dots \wedge p_n \Rightarrow q$ )
    and  $\theta' \leftarrow$  UNIFY( $q, q'$ ) succeeds
    new_goals  $\leftarrow$  [ $p_1, \dots, p_n$  | REST(goals)]
    answers  $\leftarrow$  FOL-BC-ASK(KB, new_goals, COMPOSE( $\theta', \theta$ ))  $\cup$  answers
return answers
```



Backward chaining example

Criminal(West)

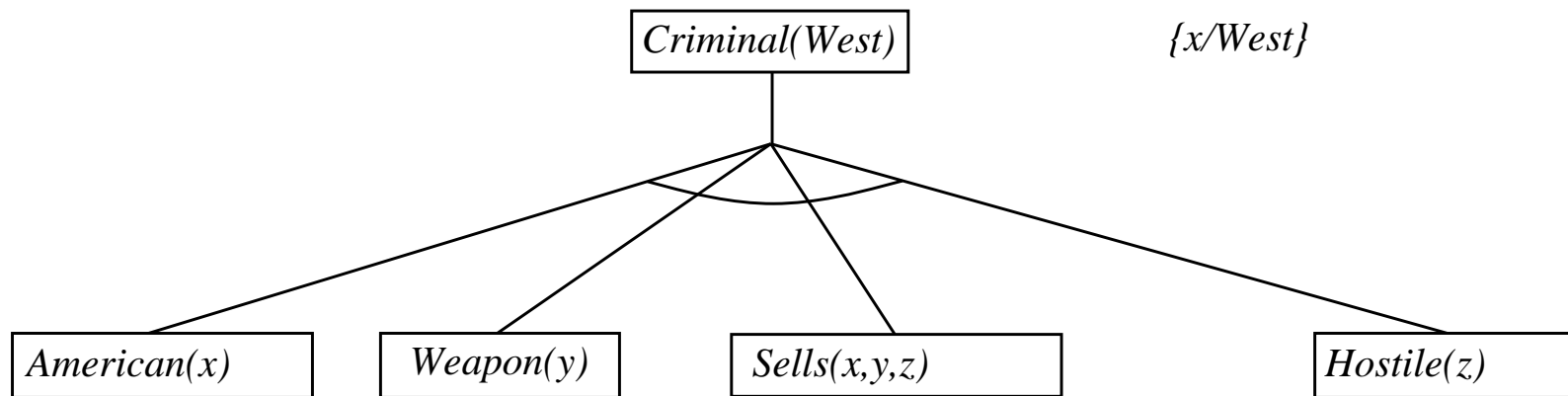
Backward chaining example

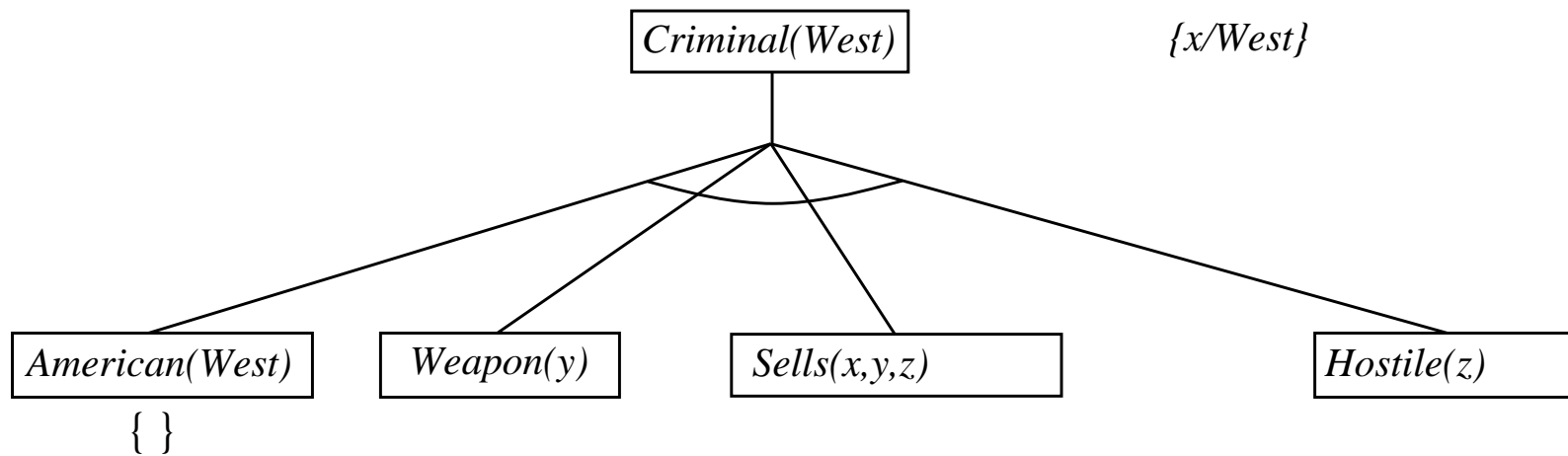

Backward chaining example



Backward chaining example

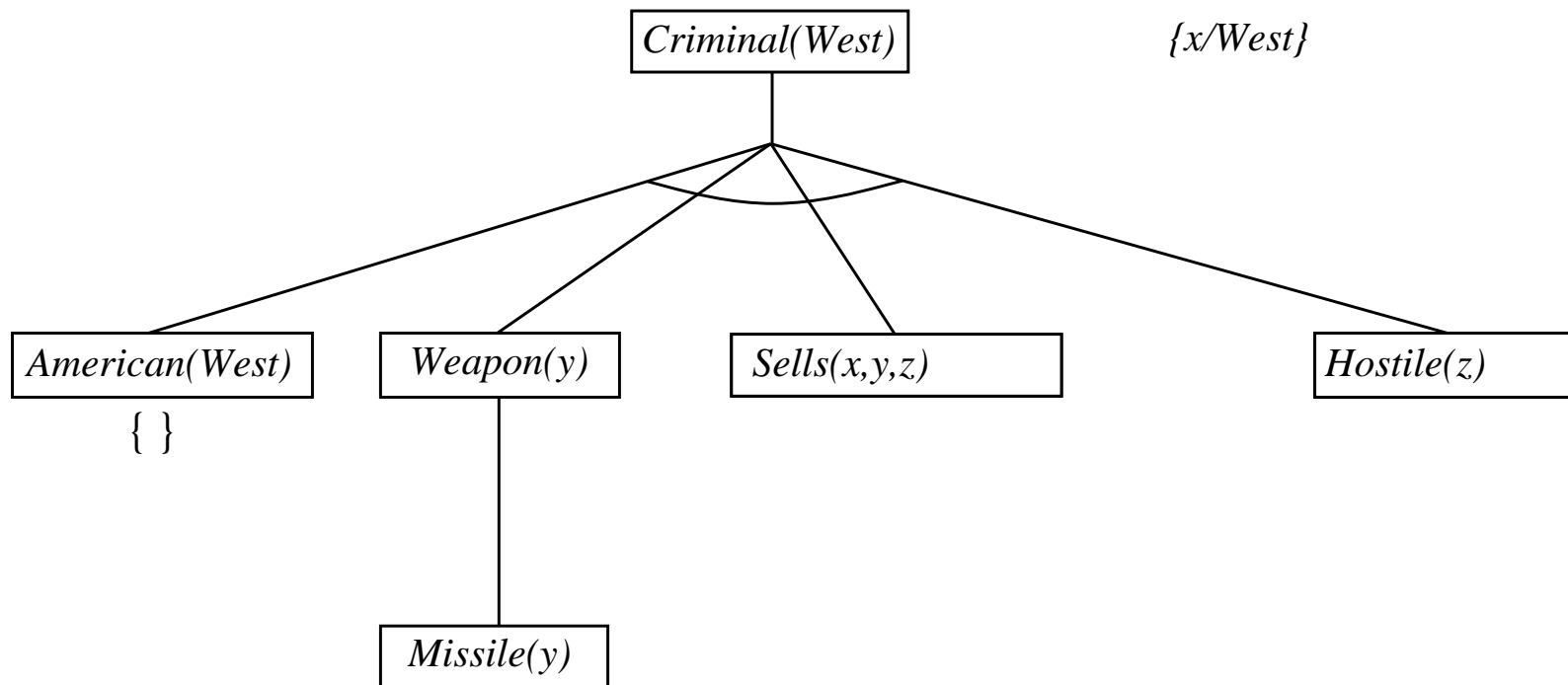

Backward chaining example

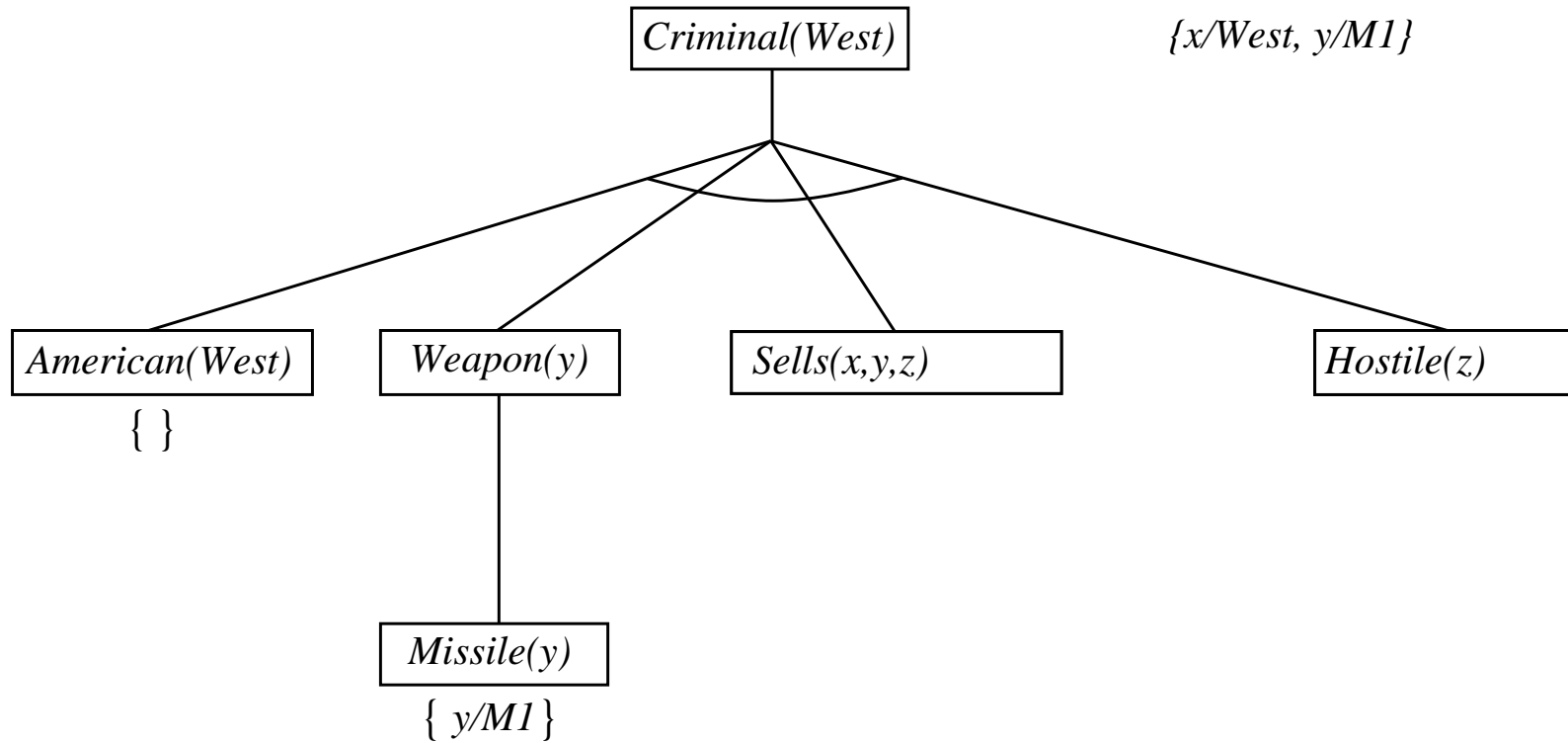

Backward chaining example

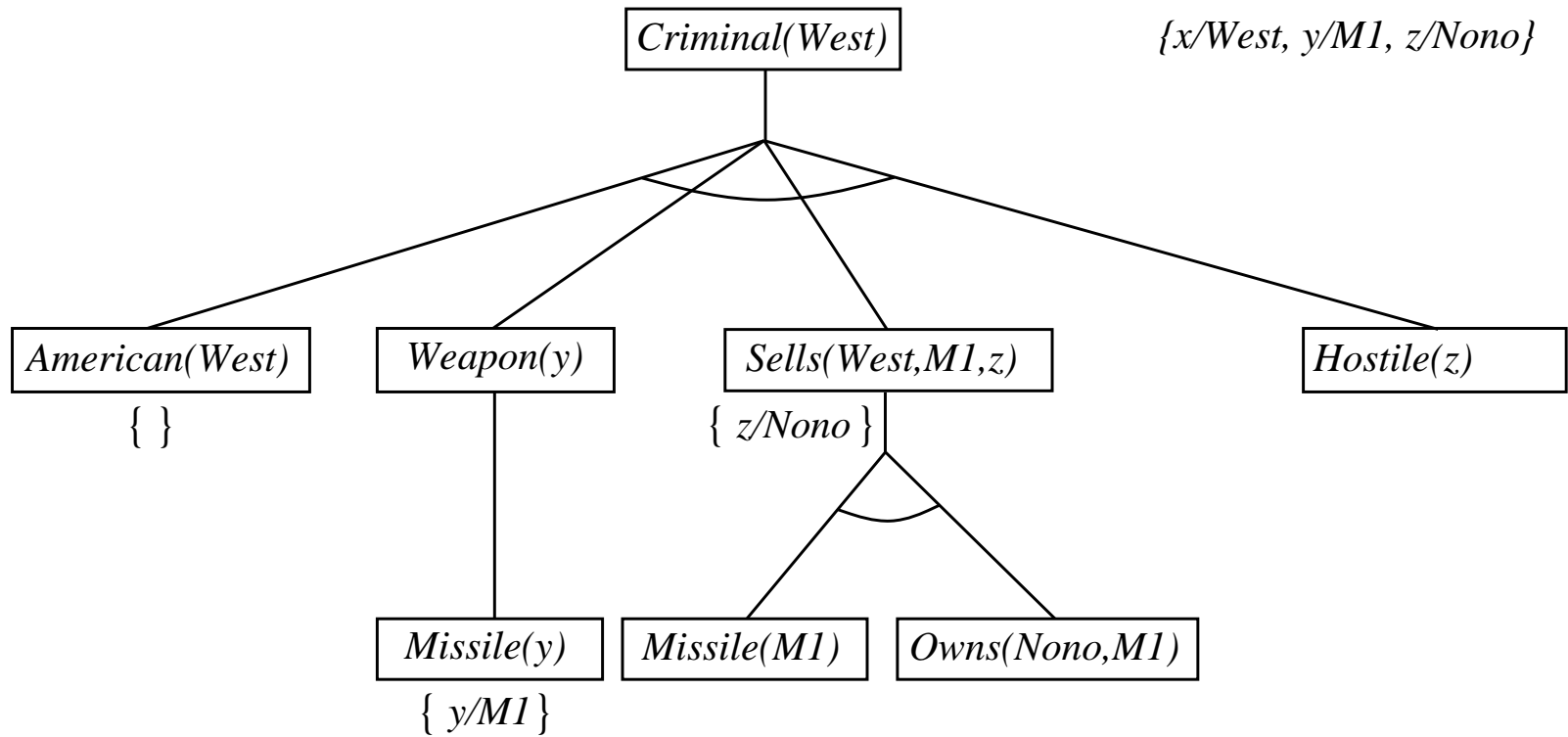

Backward chaining example

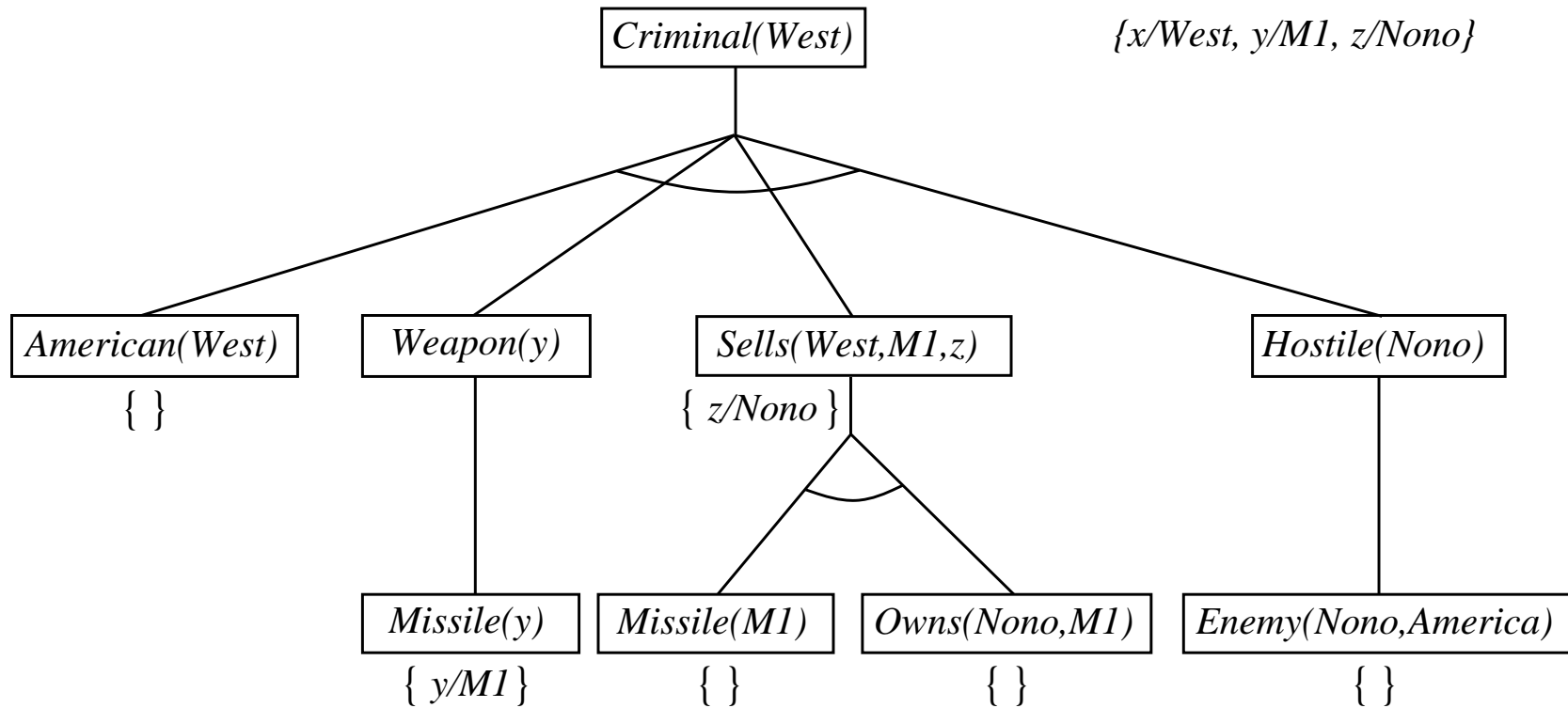

Properties of backward chaining

Depth-first recursive proof search: space is linear in size of proof

Incomplete due to infinite loops

⇒ fix by checking current goal against every goal on stack

Inefficient due to repeated subgoals (both success and failure)

⇒ fix using caching of previous results (extra space!)

Widely used (without improvements!) for [logic programming](#)

Logic programming

Sound bite: computation as inference on logical KBs

Logic programming

1. Identify problem
2. Assemble information
3. Tea break
4. Encode information in KB
5. Encode problem instance as facts
6. Ask queries
7. Find false facts

Ordinary programming

- Identify problem
- Assemble information
- Figure out solution
- Program solution
- Encode problem instance as data
- Apply program to data
- Debug procedural errors

Should be easier to debug *Capital(NewYork, US)* than $x := x + 2$!

Prolog systems

Basis: backward chaining with Horn clauses + bells & whistles

Widely used in Europe, Japan (basis of 5th Generation project)

Compilation techniques \Rightarrow approaching a billion LIPS

Program = set of clauses = head :- literal₁, ... literal_n.

```
criminal(X) :- american(X), weapon(Y), sells(X,Y,Z), hostile(Z).
```

Efficient unification by [open coding](#)

Efficient retrieval of matching clauses by direct linking

Depth-first, left-to-right backward chaining

Built-in predicates for arithmetic etc., e.g., X is Y*Z+3

Closed-world assumption (“negation as failure”)

e.g., given `alive(X) :- not dead(X).`

`alive(joe)` succeeds if `dead(joe)` fails

Prolog examples

Depth-first search from a start state X:

```
dfs(X) :- goal(X).  
dfs(X) :- successor(X,S),dfs(S).
```

No need to loop over S: successor succeeds for each

Appending two lists to produce a third:

```
append([],Y,Y).  
append([X|L],Y,[X|Z]) :- append(L,Y,Z).
```

query: append(A,B,[1,2]) ?

answers: A=[] B=[1,2]

A=[1] B=[2]

A=[1,2] B=[]

Resolution: brief summary

Full first-order version:

$$\frac{l_1 \vee \dots \vee l_k, \quad m_1 \vee \dots \vee m_n}{(l_1 \vee \dots \vee l_{i-1} \vee l_{i+1} \vee \dots \vee l_k \vee m_1 \vee \dots \vee m_{j-1} \vee m_{j+1} \vee \dots \vee m_n)\theta}$$

where $\text{UNIFY}(l_i, \neg m_j) = \theta$.

For example,

$$\frac{\neg Rich(x) \vee Unhappy(x) \\ Rich(Ken)}{Unhappy(Ken)}$$

with $\theta = \{x/Ken\}$

Apply resolution steps to $CNF(KB \wedge \neg\alpha)$; complete for FOL

Conversion to CNF

Everyone who loves all animals is loved by someone:

$$\forall x [\forall y \text{ Animal}(y) \Rightarrow \text{Loves}(x, y)] \Rightarrow [\exists y \text{ Loves}(y, x)]$$

1. Eliminate biconditionals and implications

$$\forall x [\neg \forall y \neg \text{Animal}(y) \vee \text{Loves}(x, y)] \vee [\exists y \text{ Loves}(y, x)]$$

2. Move \neg inwards: $\neg \forall x, p \equiv \exists x \neg p$, $\neg \exists x, p \equiv \forall x \neg p$:

$$\forall x [\exists y \neg(\neg \text{Animal}(y) \vee \text{Loves}(x, y))] \vee [\exists y \text{ Loves}(y, x)]$$

$$\forall x [\exists y \neg \neg \text{Animal}(y) \wedge \neg \text{Loves}(x, y)] \vee [\exists y \text{ Loves}(y, x)]$$

$$\forall x [\exists y \text{ Animal}(y) \wedge \neg \text{Loves}(x, y)] \vee [\exists y \text{ Loves}(y, x)]$$

Conversion to CNF contd.

3. Standardize variables: each quantifier should use a different one

$$\forall x [\exists y \textit{Animal}(y) \wedge \neg \textit{Loves}(x, y)] \vee [\exists z \textit{Loves}(z, x)]$$

4. Skolemize: a more general form of existential instantiation.
Each existential variable is replaced by a **Skolem function** of the enclosing universally quantified variables:

$$\forall x [\textit{Animal}(F(x)) \wedge \neg \textit{Loves}(x, F(x))] \vee \textit{Loves}(G(x), x)$$

5. Drop universal quantifiers:

$$[\textit{Animal}(F(x)) \wedge \neg \textit{Loves}(x, F(x))] \vee \textit{Loves}(G(x), x)$$

6. Distribute \wedge over \vee :

$$[\textit{Animal}(F(x)) \vee \textit{Loves}(G(x), x)] \wedge [\neg \textit{Loves}(x, F(x)) \vee \textit{Loves}(G(x), x)]$$

Resolution proof: definite clauses

